



Solar Street Light Control System Using Zigbee Network in All Climatic Conditions

T Prasanth, T Mohamed Thameem, M Kalaiyarasi, A Sajili and
M Nandhini

EasyChair preprints are intended for rapid dissemination of research results and are integrated with the rest of EasyChair.

May 21, 2022

Solar Street Light Control System using ZigBee Network in all Climatic Conditions

Mr.T.Prasanth , Mr.T.Mohamed Thameem, Ms.M.Kalaiyarasi, Ms.A.Sajili, Mrs.M.Nandhini

Abstract—The world is converging towards wireless as a communication channel and at the same time facing energy and environmental problems. The solution is by mingling the information technology (IT) and power. Streetlights are among a city's most important and expensive assets usually costs one third of the electricity bill. The proposed smart light control system outclasses the previous systems because it integrates the low power communication protocol ZigBee with the LED lights. The system reduces the power of the LED lights according to outside conditions of light intensity as it has the ability to dim the lights. The initial experimental results show that it saves remarkable power as compared to conventional systems. This efficiency increases even two fold by considering the advantage of remotely monitoring and controlling the lights through the centralized point. Thus the proposed system is the cost effective and efficient system satisfying the needs of the modern users.

Keywords- ZigBee, LED light , MCU, PLC, gateway

I. INTRODUCTION

Energy efficiency is the key factor while designing indoor or outdoor lighting systems. To efficiently utilize the limited power resources, energy efficient lighting system is needed which can manage the energy knowledgeably. However, the traditional lighting systems are not reliable because of its design based on the old lighting standards and inefficient instruments and devices. Thus, it results in energy losses, frequent replacement of devices, suffers from the lack of pervasive and effective communications, monitoring, automation, and fault diagnostics problems.

To address these challenges, many technologies has been utilized in the literature to save energy such as; the utilization of the light emitting diode (LED) instead of metal halide lamps [1], [2]. But the systems based on these technologies need further improvement to overcome the energy crisis. To further reduce the energy consumptions and to simplify the wiring structure, numerous lighting control systems have been proposed to solve that problem such as; occupancy sensing approach [3], light level tuning [4], and power line communication (PLC). Despite of reducing the wiring structure in PLC based designs presented in [5], [6], occasional drops may occur in PLC networks operating on low voltage power

lines [7]. These drops are caused by noise and attenuation, and can last from a few minutes to few tens of minutes. Due to carrier signal attenuation, there may be high latency or communication failure in PLC based design. On the contrary, deploying communication infrastructure based on wireless sensor networks (WSNs), such as low power ZigBee, eliminates wiring overheads and save lots of energy.

To implement wireless control system of lights, several comparable architectures have been applied for indoor lighting [8]-[10] and outdoor lighting [11]-[14]. The author in [13] demonstrated street lighting control using ZigBee for short distance communication similar to [12] and extends communication range by utilizing licensed band CDMA for sending information between remote concentrator and centralized control center. In references [12] and [13], both authors described preliminary result with common aim to save maintenance time, reduce energy consumption, and raise reliable level. However, while controlling the energy consumption these papers statically control the energy consumption and do not consider the user requirements in the sense of light intensity and the user's presence while dimming or turning off the lamps. By exploring previous researches [8]-[14] in the area of lighting control reveals that more effort has been made either on the lighting control inside building or outdoor lighting control by applying WSN technologies. However, still there is a demand for an energy efficient system in the market which can be utilized for both the indoor office environment and outdoor street lights with little modifications.

In order to fill this hole, we design the energy efficient ZigBee Based light monitoring and control system which helps in reducing the energy consumption of the indoor office environment and outdoor lighting environment fulfills the user satisfaction by using occupancy and illumination sensors, and gives the gate to design the advance metering infrastructure (AMI).

The rest of the paper is organized as: section II describes the ZigBee Standard overview. In section III, we present the system implementation details and Section IV discussed the results and observations. Finally in section V, we draw conclusions.

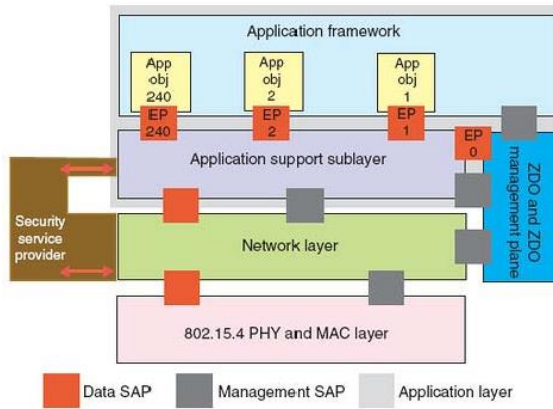

Fig.1. ZigBee Protocol Stack.

II. ZIGBEE STANDARD

ZigBee is the low power wireless network standard based on IEEE 802.15.4 and defined by ZigBee Alliance. It focuses on low power, low cost, high reliability and self healing characteristics. Solutions adopting the ZigBee standard will be embedded in consumer electronics, home and building automation, industrial controls, PC peripherals, medical sensor applications, lighting control.

The ZigBee stack architecture as shown in Fig.1 is based on the standard Open Systems Interconnection (OSI) seven-layer model. The Physical layer (PHY) and medium control layer (MAC) is being defined by IEEE 802.15.4. The application layer and network layer has been defined by ZigBee Alliance and is build on the foundation of IEEE layers. The application layer includes the application support sub-layer (APS), the ZigBee device objects (ZDO), and the manufacturer defined application objects. Each layer performs a specific set of services for the layer above.

The ZigBee network layer (NWK) has three kinds of topologies named as star, tree and mesh topologies as shown in Fig. 2. The star topology is the simplest of all and can work for the short distance only. It has end devices which are connected directly to coordinator. Tree topology has though only one coordinator but its range can be extended because it has routers which can be connected to other router and so on, but it has only one path towards the coordinator that is end device can

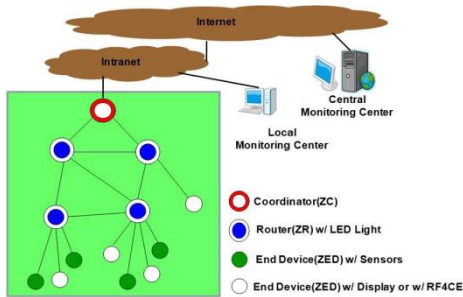

Fig. 2. ZigBee Network

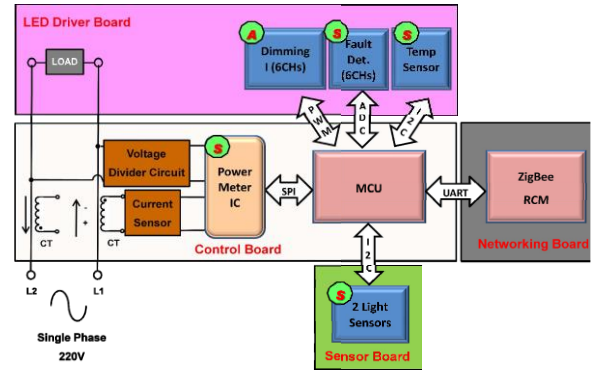

Fig.3. Node Block Diagram

send their data through a single path and if link fails all will have to suffer.

Mesh topology is the best of all topologies in respect that it has self-healing infrastructure, and has extra path which can be helpful to reach the coordinator if one fails to work. ZigBee network has coordinator, full function device (FFD) and reduced function device (RFD). Only the FFD defines the full ZigBee functionality and can become a network coordinator, it has the function of routing and relay. The RFD has limited resources and does not allow some advanced function (e.g. routing).

III. PROPOSED SMART LED SYSTEM ARCHITECTURE

The LED lamp controlling and monitoring wirelessly involves the designing of complete node. The need of such kind of node which must have an ability to send the commands wirelessly to the main control centre, and controller board which can control the LED lamp in terms of ON/ OFF and dim commands and the accessories attached to the lamp. Then the focus part of the design is the energy consumption for the benefit of user and environment concurrently. The system

comprises of ZigBee based mesh networked streetlamps, gateway node, and management software that offers real time monitoring and control of lighting system.

A. Controller

The main part of our design is the controller, which acts as the heart of the node. The controller sends the appropriate signals to the LED lights after receiving signals from the sensors. The overall functionality of the controller involved is explained by the node block diagram shown in the Fig. 3.

The node uses an 8-bit AVR MCU to control all the interfaces. The ATmega128 is a general purpose MCU with a rich set of peripherals built in. The node has, MCU Atmega128 chip, ZigBee RCM, Power metering IC, temperature sensor, light sensor, current sensor and LCD display. The ATmega128 is the heart of the board; it interfaces required devices by using its built in peripherals. ZigBee RCM has embedded EM250 chip using ZigBee wireless protocol for communication, which is programmed by using insight Desktop (IDE). It is the main part of sending to and receiving data from the control center.

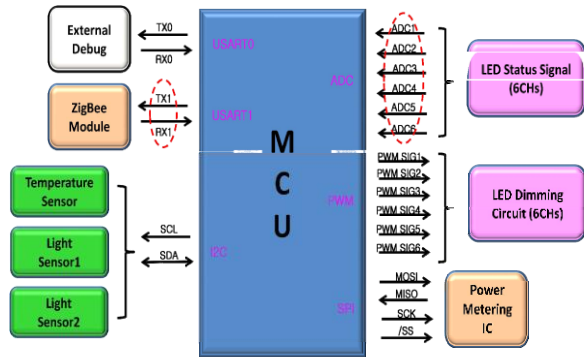

Fig.4. MCU Communication Block Diagram

B. Power Meter & Sensors

Power metering IC named ADE7753 is used to measure current, power (W) and energy, which can be measured directly by using LCD attached to node or can be send wirelessly to the control center to view it on PC. Temperature sensor is connected for the measurement of temperature of outside environment, and light sensors are attached to control board for the purpose of measuring the illumination in Lux and taking action accordingly. How these peripherals communicate with the MCU can be cleared by viewing the block diagram shown in Fig. 4.

C. ZigBee Gateway

Each lamp controller communicates with the data centre via a gateway. Gateway provides the backhaul link to the data center and ZigBee module to connect with the street light control terminal. In proposed design, attributes of LED lamps are remotely observed and controlled through ZigBee gateway (GW).

Figure 4 clearly shows that ZigBee RCM is doing communication by using USART communication, temperature and light sensor by using I2C communication, power metering IC is using SPI communication and PWM signal generated by MCU is used to dim the LED lamp according to outside condition.

D. Network Transmission

The transmission in network means that the data transfer from node to central control centre and then required command

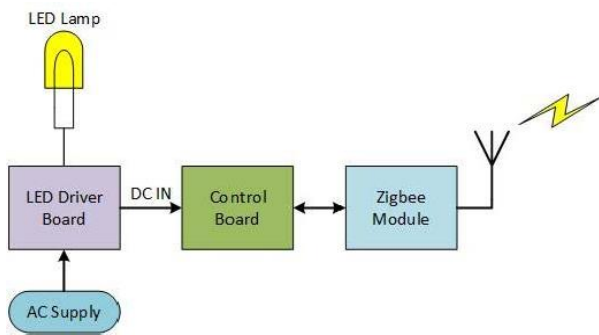

Fig.5. Transmitter Block Diagram

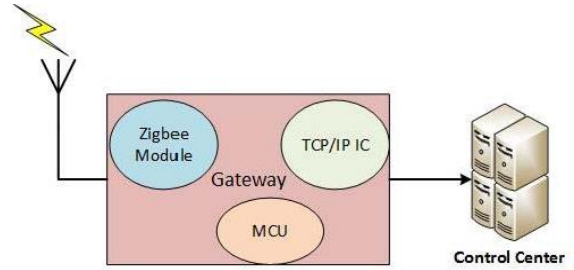

Fig.6. Receiver Block Diagram

from the control center to node, like dimming of light, turning it on/ off etc.

1) System Transmitter

Every node will act as a transmitter because it has ZigBee module for transmitting data. Our system is initially designed for one node with its block diagram shown in Fig. 5. It contains LED lamp attached to LED driver board and, temperature sensor, ZigBee module and light sensor attached to control board. The light intensity is determined by using light sensor, current is measured by using current sensor attached to a line, and power is measured using ADE chip and then these are displayed on LCD, which are then send to the receiver wirelessly, which actually is connected to a control centre to take the proper decision.

2) System Receiver

The receiver consists of ZigBee module, gateway and personal computer (PC) or control centre as shown in Fig.6. ZigBee module has the function of receiving the data send by each lighting nodes. Gateway is used as a bridge to link the wired and wireless network. It contains ZigBee module, TCP/IP connection and a MCU unit. It connects the ZigBee module to Ethernet and permit server access data from wireless sensor network by TCP/IP-based and makes it readily available to a large number of users. The PC is used to display the transmission going on in the network and is showing the status of a lamp and if it has some fault, it is marked, and then it can be easily removed and since it is connected to Ethernet by using gateway so we can access it anywhere in the world.



Fig.7. Smart LED Light Panel using ZigBee Protocol

E. Dimming of LED

The dimming of LED can be performed by varying the duty cycle of a signal as LED lights do not actually dim as LED light is emitted from a semiconductor chip and they are either on or off. The reason the light does not look like on/off is that the cycles are so fast (thousandths of seconds) that it switches between on and off and are not visible to the human eye. The LED semiconductor receives the instructions wirelessly from the ZigBee controller and changes the length of the cycle time accordingly; and what we see that the light is now “dimmed”. PWM signal generated from MCU is used for dimming of an LED; by using it we change the current level of LED lamp and hence dimming results. We only use two channels of PWM due to two LED lamps in a panel as shown in Fig. 7 and it can be extended which depends upon the light intensity needed.

F. Software Used

In engineering, software design means how to program the hardware’s using programming tools like AVR studio; the programming environment for the microcontrollers.

1) Embers Software

We use the Ember chip EM250 for the purpose of wireless communication. This chip is an embedded sys em that has to be programmed using a developing environment. Ember provides a set of tools [15] that allows us to develop a product using Ember’s ZigBee products. An overview of the toolchain that will be used to develop, build and deploy the applications is described here. These tools fall into one of thr e categories:

- EmberZNet Stack Software
- Compiler Toolchain
- Network Debugging Toolchain

The EmberZNet Stack Software is a collection of libraries, source code, tools, sample applications, and product documentation. EM250 uses a xIDE Compiler toolchain. The toolchain provides capabilities that include a compiler, linker, debugger, sample applications and user documentation. xIDE for EM250 includes project templates that we have used to build our application. These templates include all the standard settings and common source files required to build EmberZNet applications.

InSight Desktop (ISD) helps us to develop embedded applications by supporting on-the-air testing of the products in a live wireless environment. With InSight Desktop, one can

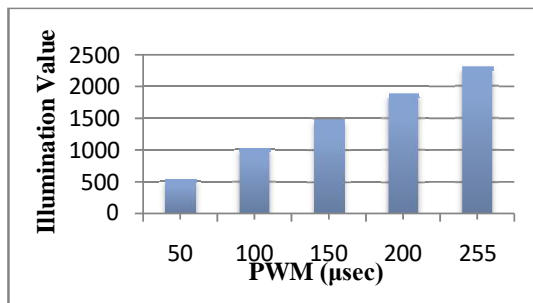

Fig.8. PWM versus Illumination

TABLE I. ILLUMINATION AT DIFFERENT PWM

PWM Value \ No. of Obs.	50	100	150	200	255
1	542	1031	1479	1881	2300
2	539	1029	1482	1883	2300
3	539	1029	1480	1885	2300
4	541	1029	1479	1882	2300
5	541	1029	1476	1876	2300
6	540	1027	1471	1875	2300
7	539	1027	1472	1874	2290
8	540	1026	1470	1875	2290
9	538	1024	1465	1870	2290
10	537	1023	1471	1871	2290

view live networks, monitor and examine debug information provided by the network devices themselves. We have used InSight Desktop with Ember development boards to set up network for developing and testing our light control embedded application before deploying it on the hardware.

2) AVR Studio

AVR Studio 4 is the Integrated Development Environment (IDE) for developing 8-bit AVR applications in Windows environments. AVRStudio4 is capable to integrate AVR-GCC compiler by using built in plug-in. AVR Studio 4 [16] is a powerful tool which has assembler compiler- debugger, programmer, etc. We program and then compiled using AVR-GCC and then checked it by programming the Atmega128 using ISP.

3) ZigBee Network Joining Process

We use the insight desktop to view the network joining process. The coordinator is respon ible for network setting. It searches for a radio channel, starts the network by assigning a PAN ID (Personal Area Network identifier) to the network, then finishes configuring itself and starts itself in Coordinator mode. It is then ready to respond to queries from other devices that wish to join the network. The coordinator after creating the network and the nodes that wish to join the network will first Search for Network. Secondly node will search for the parent node to which it connects, and then node will send the join request and in last if node satisf es the requirement of the network then coordinator will all w it to join the network. Hence this is the procedure we follow in our case.

IV. RESULTS AND OBSERVATIONS

A. PWM Value versus Illumination

We use the illumination meter to find out the maximum illumination and test the dimming ption of our light. We first fixe the PWM value and then taken the 10 readings at each PWM value, for example first we have fixed the PWM at 50

TABLE II. LCD READINGS

Current (Amp)	Power (W)	Temperature (Celsius)	ILM Inside Room (Lux)	ILM Outside (Lux)	Fixed ILM Level (Lux)
0.286	52.021	32	150	50	200
0.2857	51.023	32	140	60	200
0.2855	50.020	30	130	70	200
0.2858	49.532	29	125	75	200
0.286	49.234	30	115	85	200

and then taken the 10 values of illumination as shown in Table I and similarly for others value of PWM like 100, 150, 200, and 255 and finally we take the average of these 10 readings and plot the average value of each illumination with respect to PWM. The plot in Fig. 8 shows that our system implementing the dimming option is working properly that is by increasing the value of PWM the illumination level increases.

B. Current and Power Measurements

The current and power is measured by using ADE7753 chip which has current and power registers and interfaced with MCU using SPI communication. The current and power values are measured by using LCD display. We plot these values versus PWM signal to show the working of our node. The results shown in Fig. 8 are linear which prove that the design LED system is working properly.

C. LCD Readings

We measure the current, power, temperature and illumination (ILM) on LCD display of the 75 W lamp installed in room environment and the observations are given in table II. The results show that as the intensity of light from outside source (sun) increases then the power consumption decreases because light sensor detects the light from outside source so in order to keep the fixed illumination level it dims the LED lights. Then MCU gives signal to PWM to reduce its duty cycle and results in dimming of the light illuminating from the lamp. The power reduces as the sunlight increases and lamp dims because overall illumination level is fixed and hence needs less power to glow. Thus light automatically switch ON/OFF during night and day time and results in less power consumption. These readings are taken in a room environment and the system will reduce even more power in outside environment when installed on street lights.

V. CONCLUSIONS

We develop smart LED street light control system to remotely monitor and control the street lights. This system has been tested in the room environment for one LED lamp panel. The designed system works efficiently when installed in the room environment. It decreases the power consumption remarkably while maintaining the sufficient illumination level inside the room. The readings show that to maintain illumination level of 200 Lux for 75 W lamp, it only uses 49.23 W. Thus, the proposed smart street light control system has the capability to reduce the power consumption by adopting the environment. The analysis proved that the propose system is

low power consumption, low complexity and high reliable and not only reduces the energy consumption but also reduces the maintenance cost, labor cost, monitoring costs because of its centralized control system. Thus the designed system is working efficiently in all respect. In future, we have a plan to install our energy efficient system to street lights which usually consumes high energy in our country.

REFERENCES

- [1] W. Yongqing, H. Chuncheng, Z. Suoliang, H. Yali, and W. Hong, "Design of solar LED street lamp automatic control circuit," in *Proc. International Conference on Energy and Environment Technology*, 2009, pp. 90–93.
- [2] W. Yue, S. Changhong, Z. Xianghong, and Y. Wei, "Design of new intelligent street light control system," in *Proc. IEEE International Conference on Control Automation*, 2010, pp. 1423–1427.
- [3] C. Ozcelebi, and J. Lukkien, "Exploring user-centered intelligent road lighting design: a road map and future research directions," *IEEE Trans. Consum. Electron*, vol. 57, pp. 788–793, May 2011.
- [4] C. Chun, C. Hung, L. Kun, C. Kuan, and Y. Chun, "A digitally wireless dimmable lighting system for two-area fluorescent lamps," in *Proc. IEEE Region 10 Conference*, 2010, pp. 2173–2178.
- [5] C. SungKwan and V. Dhinra, "Street lighting control based on LonWorks power line communication," in *Proc. IEEE International Symposium on Power Line Communications and Its Applications*, 2008, pp. 396–398.
- [6] L. Chushan, W. Jiande, and H. Xiangning, "Realization of a general LED lighting system based on a novel Power Line Communication technology," in *Proc. IEEE Applied Power Electronics Conference and Exposition*, 2010, pp. 2300–2304.
- [7] H. Penagos and G. Tache, "Noise and Interference in Power Line channels," in *Proc. Electronics, Robotics and Automotive Mechanics Conference*, 2009, pp. 269–274.
- [8] A. Pandharipande and L. Shuai, "Light-Harvesting Wireless Sensors for Indoor Lighting Control," *IEEE Sensors J.*, vol.13, no.12, pp. 4599–4606, Dec. 2013.
- [9] R. Xue, N. Ping, and W. Wei, "A Novel Design of Solid-State Lighting Control System," in *Proc. Asia-Pacific Conference on Wearable Computing Systems*, 2010, pp. 213–216.
- [10] Y. Wen and A. Agogino, "Personalized dynamic design of networked lighting for energy-efficiency in open-plan offices," *Energy and Buildings*, vol. 43, no.8, pp. 1919–1924, Aug. 2011.
- [11] D. Caicedo and A. Pandharipande, "Distributed illumination control with local sensing and actuation in networked lighting systems," *IEEE Sensors J.*, vol. 13, no. 3, pp. 1092–1104, Mar. 2013.
- [12] J. Lin, X. Jin, and Q. Mao, "Wireless monitoring system of street lamps based on ZigBee," in *Proc. Wireless Communications, Networking and Mobile Computing*, 2009, pp. 1–3.
- [13] J. D. Lee, K. Y. Nam, S. H. Jeong, S. B. Choi, H. S. Ryoo, and D. K. Kim, "Development of ZigBee based street light control system," in *Proc. IEEE Power Systems Conference and Exposition*, 2006, pp. 2236–2240.
- [14] F. Leccese, "Remote-Control System of High Efficiency and Intelligent Street Lighting Using a ZigBee Network of Devices and Sensors," *IEEE Trans. Power Del.*, vol. 28, no. 1, pp. 21–28, Mar. 2013.
- [15] <http://www.embers.com>
- [16] www.atmel.com